

WARNING: CAREFULLY READ THE FOLLOWING INSTALLATION INFORMATION.



Models: **Wave3**
Wave6
Wave8

Catalytic Safety Heater

EFFECTIVE DATE: APRIL 2007

Your Olympian™ heater is designed and built to provide years of comfortable, radiant heat and economical LP gas consumption. In order to minimize installation problems and maximize your heating comfort, read all of these instructions carefully and completely.

Olympian heaters produce mostly radiant heat as a result of a flameless catalytic combustion process. Its efficiency is high because combustion takes place at relatively low temperatures.

The wavelength of the radiant heat produced by Olympian heaters is particularly effective for creating a feeling of warm comfort similar to solar radiation. The sun is an excellent example of radiant heat transfer, because it transmits energy through space, releasing heat when its rays strike objects and people.

Like the sun, Olympian heaters radiate heat directly to people, floors, walls and other objects without heating the air first, so warmth is felt immediately. Radiant heat is absorbed by objects and then emitted into the air to heat the surrounding area. Therefore, your Olympian heater should be oriented to direct its heat

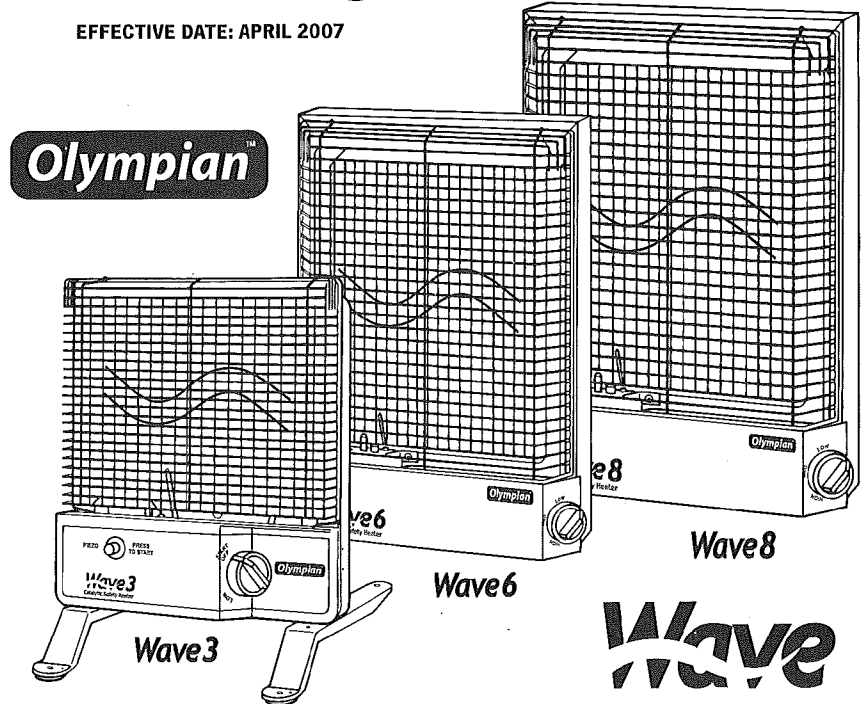

rays toward the space to be heated, much like a floodlight is positioned to illuminate a desired area. Avoid placing furniture or objects in a place that will block the heat rays.

Your Olympian heater has undergone rigorous safety, performance and quality assurance testing before leaving the factory. It is designed to deliver years of trouble-free service.

The INSTALLER must leave this set of instructions with the owner after installation is completed. (IMPORTANT: Installers must have the owner fill out and mail the warranty card supplied with each heater.) The OWNER should read this entire manual to be assured of a satisfactory installation and to fully understand operating procedures. Keep these instructions in a safe, convenient place for future reference.

Installation and Operating Instructions

This is a heating appliance. Any safety screen or guard removed for servicing must be replaced prior to operating the heater.



Warning

Any changes or alterations to this heater or its controls (or attempts to clean the catalytic pad) can result in damage, defective operation, and danger.

NOTICE

If product components are missing or damaged do not return to dealer.
Contact the manufacturer at (336) 668-7661

IMPORTANT SAFETY PRECAUTIONS

⚠ Warning ⚠

Read thoroughly and understand all warnings, cautions and instructions in this manual and on the heater before installing, operating, or having your Olympian™ catalytic heater serviced. Failure to comply with the warnings, cautions and instructions could create conditions causing fire, explosion, asphyxiation and/or burns, thereby causing injury, death and/or property damage.

For assistance, consult a qualified installer, service agency, your gas supplier, or the factory.

For your safety

If you smell gas:

1. Do not try to ignite any appliance.
2. Open windows.
3. Do not touch any electrical switch; do not use any phone in your building.
4. Extinguish open flames.
5. Call gas supplier from a neighbor's phone.
6. Shut off propane at tank.

⚠ Warning ⚠

Fire, burn and explosion hazard

Do not use this heater in a space where flammable or explosive materials, liquids, vapors or particulate dusts are being stored, used or are otherwise present. Examples of such materials are gasoline, naphtha, kerosene, varnishes, lacquers, paints, mineral spirits, acetone and other thinners, flammable gases, and chemical and grain dusts. Consult your local fire marshal for specific hazards.

⚠ Warning ⚠

The heater consumes air from the space in which it is used. Sufficient fresh air must be provided to assure complete combustion of the fuel gas. Improper combustion can result in the production of poisonous carbon monoxide, causing danger of asphyxiation and death. Carbon monoxide is an odorless, colorless gas. Symptoms of carbon monoxide poisoning often cannot be recognized before losing consciousness.

KEEP THIS MANUAL FOR FUTURE REFERENCE

SAFETY INFORMATION FOR USE OF LP GAS

Propane (LP Gas) is a flammable gas that can cause fires and explosions. In its natural state, propane is odorless and colorless. You may not know all of the following safety precautions that can protect both you and your family from an accident. Read them carefully now, then review them point by point with the members of your household. Someday, when there may not be a minute to lose, everyone's safety will depend on knowing exactly what to do. If, after reading the following information, you feel you still need more information, please contact your gas supplier.

LP Gas Warning Odor

If a gas leak happens, you should be able to smell the gas because of the odorant put in the LP Gas. That's your signal to go into immediate action!

- Do not operate electric switches, light matches, or use your phone. Don't do anything that could ignite the gas.
- Get everyone out of the building, vehicle, trailer or area IMMEDIATELY.
- Close all gas tank or cylinder-supply valves.
- LP Gas is heavier than air and may settle in low areas such as basements. If you have reason to suspect a gas leak, keep out of basements and other low areas. Stay out until firefighters declare them to be safe.
- Use your neighbor's phone and call a trained LP Gas service person and the fire department. Even though you may not continue to smell gas, do not turn on the gas again. Do not re-enter the building, vehicle, trailer or area.
- Finally, let the service man and firefighters check for escaped gas. Have them air out the area before you return. Properly trained LP Gas service people should repair the leak, then check and relight the gas appliance for you.

No Odor Detected - Odor Fade

Sometimes, for environmental or health reasons, not everyone can smell the chemical odor put into gas. You must find out if you can smell the odorant in propane. Smoking can decrease your ability to smell. Also, being around an odor for a period of time can affect your sensitivity or ability to detect that odor. Sometimes other odors in the area mask the gas odor. People may not smell the gas odor if their minds are on something else. Thinking about smelling a gas odor can make it easier to detect.

The odorant in LP Gas is colorless, and it can fade under some circumstances. For example, if there is an underground leak, the movement of the gas through soil can filter the smell. Odorants in LP Gas are also subject to oxidation. This fading can occur if there is rust inside the storage tank or in iron gas pipes.

The odorant in escaped gas can absorb onto or into walls, masonry, and other materials and fabrics in a room. This will take some of the odorant out of the gas, reducing its odor intensity.

LP Gas may stratify in a closed area, and the odor intensity could vary at different levels. Since it is heavier than air, there may be more odor at lower levels. Always be sensitive to the slightest gas odor. If you detect any smell, treat it as a serious leak. Immediately go into action as instructed earlier.

SAFETY INFORMATION FOR USE OF LP GAS (cont.)

Some Points to Remember

- Learn to recognize the odor of LP Gas. Your local LP Gas dealer can give you a "Scratch and Sniff" pamphlet. Use it to find out what propane odor smells like. If you suspect that your LP Gas has a weak or abnormal odor, call your LP Gas dealer.
- If you are not qualified, do not light pilot lights, perform service, or make adjustments to appliances on the LP Gas system. If you are qualified, consciously think about the odor of LP Gas prior to and while lighting pilot lights, performing service, or making adjustments.
- Sometimes a basement or a closed-up house has a musty smell that can cover-up LP Gas odor. Do not try to light pilot lights, perform service, or make adjustments in an area where the conditions are such that you may not detect the odor if there has been a leak of LP Gas.
- Odor fade, due to oxidation by rust or absorption on walls of the new cylinders and tanks, is possible. Therefore, people should be particularly alert and careful when new tanks or cylinders are placed in service. Odor fade can occur in new tanks, or reinstalled old tanks, if they are filled and allowed to sit too long before refilling. Cylinders and tanks that have been out of service for a time may develop internal rust, which will cause odor fade. If such conditions are suspected to exist, a periodic sniff test of the gas is advisable. If you have any question about the gas odor, call your LP Gas dealer. A periodic sniff test of the LP Gas is a good safety measure under any circumstance.
- If, at any time, you do not smell the LP Gas odorant and you think you should, assume you have a leak. Then take the same immediate action recommended above for the occasion when you do detect the odorized LP Gas.
- If you experience a complete "gas out" (the container is under no vapor pressure), turn the tank valve off immediately. If the container valve is left on, the container may draw in some air through openings such as pilot-light orifices. If this occurs, some new internal rusting could occur. If the valve is left open, then treat the container as a new tank. Always be sure your container is under vapor pressure by turning it off at the container before it goes completely empty or by having it refilled before it is completely empty.

SAFETY INFORMATION FOR USE OF LP GAS (cont.)

Gas Supply

The installation must conform to local codes. In the absence of local codes, the installation must conform with American National Standard (National Fuel Gas Code) known as NFPA 54 and ANSI Z223.1 2002 or the latest edition (Available from the American National Standard Institute, Inc., (HQ) 1819 L Street NW, 6th Floor, Washington, DC 20036 Phone - 202-293-8020 / Fax - 202-293-9287 or (OPS) 25 W 43rd Street, 4th floor, New York, NY 10036 Phone - 212-642-4900 / Fax - 212-398-0023).

The heater is designed to operate with a manifold pressure (the gas pressure downstream from the appliance controls) of 10.5" w.c. (0.38 psig). A gas supply pressure of 11" w.c. (0.40 psig) minimum is required at the heater controls.

The supply line must be equipped at the cylinder with a listed low pressure LP regulator set to deliver the specified pressure.

Operation of the heater at lower pressures can cause improper combustion and lower operating efficiency. Operation at higher pressure can cause improper combustion or release of unburned gas.

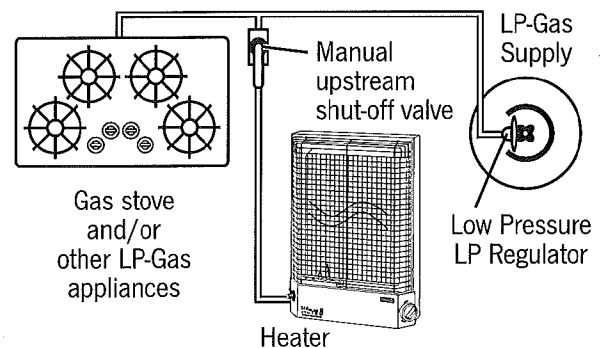

The heater is furnished with a 3/8" male SAE fitting for connection to the gas supply.

A union must be provided directly at the gas inlet to the heater. A manual gas valve must be provided upstream of the union. The heater must be isolated from the gas supply by closing this valve during any pressure testing of the gas supply piping system at pressure equal to or less than 0.50 psig (13.85" w.c.). The heater and its individual manual shut-off valve must be disconnected from the gas supply piping system during any pressure testing of the system at test pressures in excess of 0.50 psig. (3.45 kPa)

INSTALLATION INSTRUCTIONS

! CAUTION !

Many codes and regulations do not allow the use or storage of portable LP Gas cylinders larger than 2 lb. water capacity in structures. Check with your local regulatory authority before using your Olympian heater indoors with larger cylinders.

Fuel

The heater is designed for use with HD-5 propane gas only. Do not attempt to convert it for use with natural gas, other LP Gases, or other fuels gaseous or liquid. Use of any propane gas other than HD-5 may cause damage to the catalytic heating element.

Locations

Due to high temperatures, the appliance should be located out of traffic and away from furniture and draperies. Children and adults should be alerted to the hazard of high surface temperature and should be kept away to avoid burns or clothing ignition. Young children should be carefully supervised when they are in the same room with the appliance.

The ideal location for the operation of your heater is as low as possible to radiate heat in the frontal direction. The heating element will throw a beam of infrared heat. Ideally, this beam of heat should be pointing at the area, objects or persons you wish to heat. The infrared heat beam will heat up the objects and then become convection heat, eventually heating the surrounding air.

If you have a question regarding the location for installation of your heater, call Technical Support at (336) 668-7661.

Do not place clothing or other flammable material on or near appliance. **INSTALLATION AND REPAIR SHOULD BE DONE BY A CERTIFIED LP GAS SERVICE TECHNICIAN.** The appliance should be inspected before use and at least annually by a professional service person. More frequent cleaning may be required due to excessive lint from carpeting, bedding material, etc.

The heater may be installed in a variety of fixed locations. It also may be used as a portable heater by using optional leg stands.

Consistent with other requirements, keep the gas supply line from the tank to the heater as short as possible.

The installation including that of the gas supply system must conform with all applicable state and local codes and with the National Fuel Gas Code ANSI Z223.1 2002.

Installation should be performed only by qualified LP gas service personnel familiar with non-vented gas space heaters. See section titled **Gas Supply**.

Clearances from combustible materials must be a minimum of:

- 4" from each side
- 4" from the floor (rug, tile, etc.)
- 18" from the top
- 30" from the front
- 0" from the rear

Heater Connection

The connectors must be checked and cleaned before assembly and then wrenched securely for a gas-tight connection. **Two wrenches must be used:** one wrench to prevent the fitting on the heater from turning and the other wrench to tighten the fitting on the hose or pipe. Apply Camco Gas Leak Detector to joints and watch for bubbles to check for gas leaks.

DO NOT USE ANY EXPOSED FLAME TO CHECK FOR LEAKS. DO NOT OVERTIGHTEN.

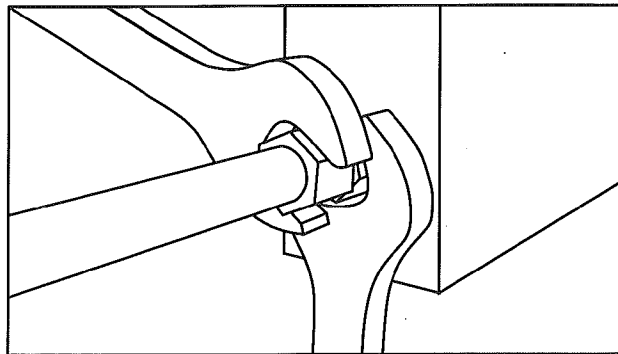

Mounting Heater on Wall

The Olympian™ Wave 3, Wave 6 and Wave 8 can be hung on the wall in a vertical or horizontal position.

Controls must be at the bottom when the heater is mounted vertically.

Controls must be at the right with the control knob at the upper right corner when the heater is mounted horizontally. This is for easy use and proper operation of the heater.

Follow these easy mounting steps:

1. Material on which heater is to be mounted must be firm and structurally strong.
2. Screws and plastic anchors for installation are found in the accessories bag furnished with the heater.
3. Cut out the four corners on the Mounting Template furnished with the heater. Use the Template to locate vertical or horizontal mounting hole positions.
4. Drill 3/8" diameter hole in wall for plastic anchors, according to horizontal or vertical surface installation holes on mounting template.
5. Push plastic anchors into the holes.

INSTALLATION INSTRUCTIONS (cont.)

6. Thread screws in the plastic anchors.
7. Hang heater on the screws, and allow to slide into place.
8. Check for clearance. If adjustment is necessary, remove heater and loosen or tighten screws. Repeat steps 7 and 8 until heater is firmly mounted.

NOTE: Screw head should be approximately 5/16" from wall to ensure tight installation.

9. Connect heater to the gas supply. The installation must be made so that the gas supply shut-off valve at the heater is readily accessible.

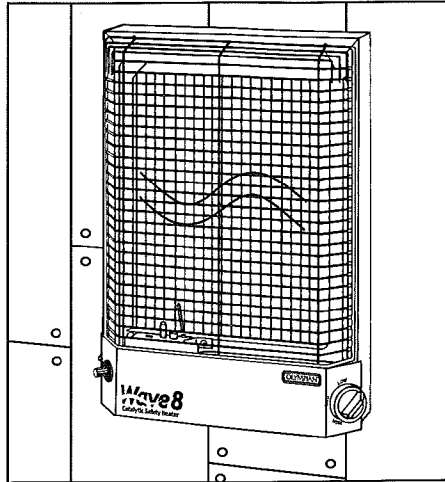

Vertical Wall Mounting

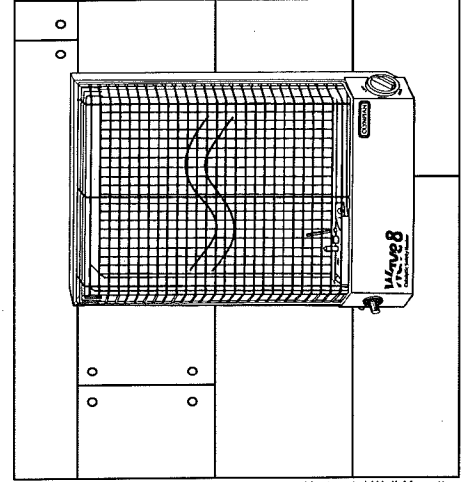

Horizontal Wall Mounting

Recessed Horizontal or Vertical Installation

Olympian™ Wave 6 and Wave 8 Heaters may be recessed into the wall in either the horizontal or vertical position. Follow these easy mounting steps:

1. Purchase Chrome Recess Mounting Kit 57692 for the Wave 6 or Kit 57695 for the Wave 8.
2. Using the Template supplied with Recess Mounting Kit, carefully trace outline of cutout onto the area to be removed. **BE SURE THERE ARE NO ELECTRIC, WATER OR GAS LINES IN AREA TO BE CUT OUT.**
3. Cut out and remove wall section.
4. Slip the mounting ring over the face of the heater until the distance from the front of the recess ring to the back of the case is 1-3/4". This is the maximum recess depth.
5. Using the ring as a template, carefully drill 7/64" diameter screw holes through the heater case at the side and top. Be careful of internal gas lines.
6. Fasten the recess mounting ring to the heater case, using the #6 x 3/8" lg panhead tapping screws included in the recess mounting kit.
7. Fasten the heater and mounting ring assembly to the wall, using #6 x 3/8" lg panhead tapping screws.
8. Connect the heater to the gas supply. The installation must be made so that the gas supply shut-off valve at the heater is readily accessible. (Refer to page 5 of Installation Instructions: **Heater Connection.**)

Outdoor Portable use of Heater

Optional leg stands may be purchased to allow portable use of your Olympian Wave Heater. Order #57701 Leg Stand Kit.

For most portable installations the heater is used with a standard 20 lb. or less gas capacity LP Gas cylinder fitted with an LP Gas hose, low pressure regulator, and cylinder connector.

⚠ Warning ⚠

The Wave 3 Olympian Heater is not designed to be operated in a recessed position. Such an installation could cause overheating and the danger of fire.

Recommended Installation

For Recommended Installation do not exceed 1 3/4" from the back of the heater to the front of the recess ring.

Maximum recess depth.

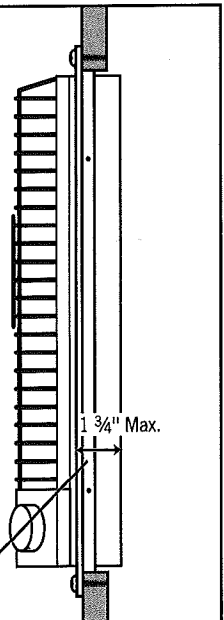

OPERATING INSTRUCTIONS

! CAUTION !

IMPORTANT: On initial lighting from a cold start, a slight odor or propane smell may be noticed for a short period of time. This is normal. If odor persists, do not continue to use heater. Shut the heater off and have it serviced.

IMPORTANT: When operating the heater in the horizontal position, it is harder to start than when it is in the vertical position. Because of this, it may take longer for complete ignition to occur, and the propane odor may last for a longer period. If, however, it does not go away, the heater should be shut off and serviced.

! CAUTION !

After heater is turned off, wait at least 5 minutes before relighting the heater.

TO RELIGHT HEATER, REPEAT THE LIGHTING AND ADJUSTMENT STEPS.

! CAUTION !

If the heater is to be left OFF for a considerable period of time, the gas supply to the heater should be turned off as close to the gas source as possible (See illustration on pg. 4 under Gas Supply).

In the case of wall-mounted heaters, this can be at the manual gas valve near the heater or further upstream (See illustration on pg. 4 under Gas Supply).

In the case of portable use, the gas should be turned off at the LP Gas storage cylinder valve.

Do not attempt to service or clean heater while it is hot. Failure to follow this instruction can result in painful burns.

! CAUTION !

Use only your hand to push in or turn the gas control knob. Never use tools. If the knob will not push in or turn by hand, don't try to repair it; call a qualified service technician. Force or attempted repair may result in a fire or explosion.

! CAUTION !

Do not use this appliance if any part has been under water. Immediately call a qualified service technician to inspect the appliance and to replace any part of the control system and any gas control that has been under water.

Air Supply

The heater consumes air from the room in which it is installed. To assure complete combustion, an adequate fresh-air supply to the room is necessary. It is good practice to have at least two openings, one high and one low. The room must have a total of at least 24 square inches free-air opening (i.e. an opening of 4" x 6" = 24 square inches). Provide additional ventilation of at least 2 square inches for every 1,000 BTUs per hour of input for any additional fuel burning appliances used at the same time. If the room is tightly sealed or insulated so that natural infiltration is low, additional ventilation is required (see below).

For RV Use (Free open-air space: 24 sq. in. min.)

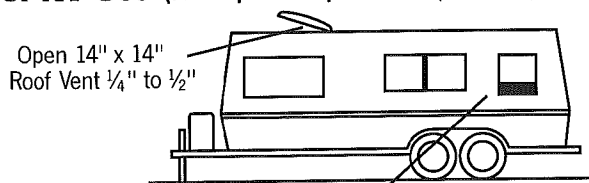

Open 8" wide window 1/4" to 1/2" at opposite end, as low as possible.

For Home Use (Free open-air space: 24 sq. in. min.)

Open two 8" wide windows 1 1/2" at opposite sides.
(If possible open one window at the top and one at the bottom.)

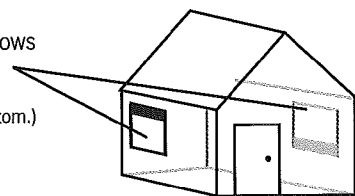

For Tent Use (Free open-air space: 24 sq. in. min.)

Open 8" wide roof flap 1 1/2"

Open entry door flap at lowest point by 8" x 1 1/2" wide.

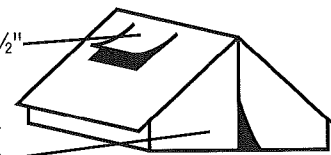

Some shelter materials such as fabric tents are often thought of as not being airtight, but do become almost impervious to air and gas passage when wet or covered with snow. Special precautions must be taken to provide enough air for efficient combustion and for breathing by the occupants (see above).

OPERATING INSTRUCTIONS (cont.)

⚠ Warning ⚠

For Your Safety Read Before Lighting!

WARNING: If you do not follow these instructions exactly, a fire or explosion may result causing property damage, personal injury, or loss of life.

BEFORE LIGHTING smell all around the appliance area for gas. Be sure to smell next to the floor because LP Gas is heavier than air and will settle to the floor.

- Only use HD-5 propane gas.
- Do not attempt to clean catalyst pad. Follow cleaning instructions accompanying heater.
- Do not use heater if the catalytic pad becomes torn or damaged. The heater should then be serviced by a licensed or qualified service person.

If you smell gas:

1. Do not try to light any appliance.
2. Open windows.
3. Do not touch any electrical switch; do not use any phone in your building.
4. Extinguish open flames.
5. Call gas supplier from a neighbor's phone.
6. Shut off propane at tank.

Lighting and Operating Instructions

1. **STOP! Read the safety instructions above.**
2. Turn heat control knob to OFF.
3. Make sure gas supply is turned on and gas is available at the heater.
4. Set heater control knob to START position and depress firmly for 10 seconds. This will allow gas flow into gas lines and will remove air from gas lines. You should hear gas flowing to the heater pad. **NOTE: Pressing knob and holding it for 10 seconds is only required the first time you start your heater. Thereafter, holding the gas knob for 5 seconds should be ample time.**
5. While continuing to hold control knob in, press PIEZO sparker button one or more times until gas-flame spreader is lit. The flame spreader should now be on. If not, repeat pressing PIEZO sparker button until flame spreader is lit.
6. After initial ignition occurs, keep control knob depressed for 45 to 60 seconds maximum. By this time the safety thermocouple should be heated enough to keep the gas valve open.
7. When ignition occurs you will see small blue flames playing over the catalyst pad face while it heats up. This flaming is normal during start-up of the heater as this begins the catalytic combustion process. Flaming may occur several times during the heating up period.
8. Release the control knob and immediately turn it to HIGH heat setting. The initial small blue flames should become extinguished and the catalytic combustion process is now taking place. **NOTE: Flame Spreader will go out immediately upon releasing the control knob.**
9. Allow the heater to operate on HIGH for 10 minutes to assure even heating of the catalyst pad. You may now set to Low or Medium.
10. Adjust the heat to the desired setting by slightly depressing and turning the control knob. Adjustments can be made periodically as desired. **DO NOT adjust in between HI-MED-LOW knob settings.**
11. To turn the heater off, turn the control knob to the OFF position.
12. **IMPORTANT: On initial lighting from a cold start, a light flame will be evident at the heater face. This is normal while the catalyst pad heats up. If flame continues even in a local area after the pad heats up, do not continue to use the heater. Shut the heater off and have it serviced.**

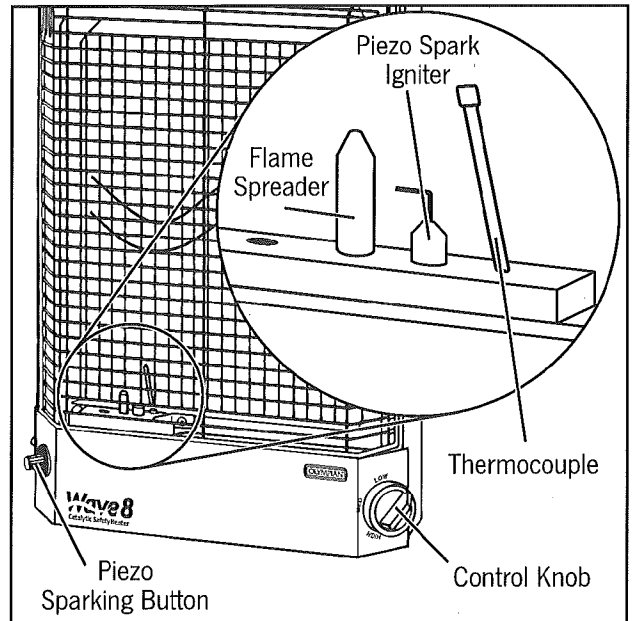

OPERATING INSTRUCTIONS (cont.)

Red Glowing on Heating Element

The red glowing on the face of the heater (particularly noticeable in the dark) will resemble charcoal glowing when hot. This is a normal phenomenon of catalization. A properly operating heater will slightly "glow" on about 40% of the bottom area of the heating element. At times, a high glow "spot" may be seen on the heating element. This is normal. The glowing phenomenon diminishes over a period of years usage.

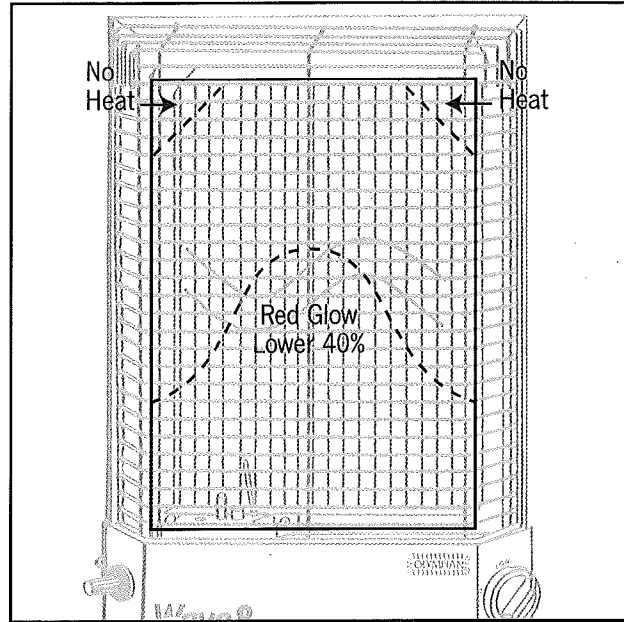

CARE OF HEATER

Cleaning

The heater and its surroundings should be kept clean and free of dust.

- It is recommended that the heater be kept covered at all times when not in use. Custom-made dust covers are available from the factory or your local dealer (see chart below for part number). **DO NOT COVER HEATER WHILE IT IS HOT.**

	<u>Wall Mounted</u>	<u>Portable</u>
Wave 3	57706	57722
Wave 6	57713	57723
Wave 8	57715	57724

- Never touch, vacuum or wash off the catalyst pad. This may destroy the active catalytic platinum surface and make the pad inoperable.

Service

With good care and normal operating conditions, your Olympian™ Catalytic Heater should provide many years of warmth and comfort.

The following service tips will assist you in taking care of the heater.

- The gas supply system to the heater should be checked periodically by a qualified LP gas service technician. If the heater will not light, will not stay lit, or does not put out the normal amount of heat, the very first thing to do is check the gas supply. Find out if the gas is available at the heater. Check LP regulator to ensure correct manifold pressure.

- Operation of the heater should be checked by a qualified LP gas service technician when the heater has been out of service for a considerable period (intermittent operation) and in any event at least once a year.
- For continued high efficiency operation, it is recommended that the catalyst pad be replaced every seven years, **and sooner if abnormal operation of the pad is noticed.** Catalyst pad replacement must be done at the factory or by a certified LP Gas technician.
- The heater has no moving parts except in the gas supply and control system. Because of this, part replacement is minimal and only a few parts can be replaced in the field. The parts described herein can be easily replaced in the field.
- Users should not attempt to repair or change any parts of the heater. All repairs must be performed at the factory or by a qualified LP Gas technician.

Piezo Electric Igniter

If no spark is obtained when the igniter button is pressed several times, the Piezo Igniter (Part #57800) or Ceramic Spark Plug (Part #57784) may need replacement. These parts are available through the factory.

CARE OF HEATER (cont.)

Thermocouple

If the heater will not stay lit when the control knob is released, the thermocouple (Part #57794) either: a) is not connected tightly to the control valve, b) is not positioned properly on the catalyst pad, or c) is faulty and needs replacement. The thermocouple should produce 15 mv, which can be checked by your gas supplier. If there is no voltage or low voltage output and thermocouple is properly placed and connected, it should be replaced by your gas supplier. The thermocouple tip should be touching the catalytic heating element.

When replacing the thermocouple, care must be taken to place it in the exact same position as the original part.

! CAUTION !

Do not perforate or otherwise injure the catalyst pad when replacing the thermocouple.

Return to Factory

If gas supply, igniter and thermocouple are all O.K. and the heater still will not operate properly, *it must be returned to the factory or sent to a qualified LP Gas technician for testing and service.*

Alterations to the heater or to its controls can result in faulty operation that may create hazardous conditions.

Catalyst Pad "Poisoning"

The catalytic process burns gas in air to produce infrared heat without flame! The operational surface temperature of the catalytic heating element is 720°F maximum, well below the temperature of conventional flame type heaters, which operate at 2,100°F. For this reason, catalytic heaters are considerably safer than conventional flame type heaters. The process works because the gas and air are brought together in the presence of the platinum catalyst. Gas goes through the pad from the back, mixes with air on the surface, and a chemical reaction occurs to release heat without flame.

The heater has a high efficiency as long as the catalyst material is intact. If partially or completely blocked, the catalytic process does not work. This is called "Catalytic Pad Poisoning." It usually can be noticed by reduced heat, propane odor, and/or difficulty in lighting, or inability of the heater to light partially or completely.

Catalyst Pad deterioration can be caused by:

- **Improper gas**
- **Impurities in the gas**
- **Impurities in the air**
- **Physical abuse**

Use of improper gas: Your heater is designed to burn HD-5 propane. Use of other LP gases such as those too high in sulfur, propylene or other hydrocarbons may injure the catalyst pad. Gas or sludge from the inside of old or dirty cylinders may block out the catalyst and prevent it from working.

Dirty or improper gas may plug the orifice and restrict the gas supply to the catalyst pad. Symptoms of this are:

- Heater won't light or will only light partially
- Gas odor
- Reduced heat output

These orifices cannot be replaced in the field. The heater must be returned to the factory for service or repaired by a qualified LP Gas technician.

Airborne Contamination: Airborne chemical compounds such as lead from motor fuel and sulfur from industrial processes are contaminants. Cooking oils, aerosol compounds, vapors from machining processes, agricultural chemicals, animal waste, airborne dirt, and alkali dust can all cause catalyst pad deterioration.

Physical abuse: Catalyst pads can be damaged by attempting to wash, vacuum or brush off the surface of the pad or by physically poking a hole in the pad surface. Such actions may remove the catalyst. Never attempt to use a pad with a damaged or perforated surface.

If catalyst pad poisoning is known or suspected, take the heater out of service and return it to the factory or take it to a qualified LP Gas technician for service. Do not attempt to operate the heater with a damaged or poisoned catalyst pad.

Determine the cause of the problem if possible. Olympian Heaters are designed to give good service for many years if used under proper conditions. Warranty does not cover catalyst pad poisoning from any cause as they are beyond the Company's control and are not a defect in manufacturing and workmanship.

Over a period of years, even under good operating conditions, some of the catalyst sites may be rendered inoperative because trace contaminants almost always are present in the gas and in the air. If lowered heat output is noticed, it is possibly time to have the catalyst pad replaced.

Catalyst pad poisoning can cause lowered heat output and release of unburned or partially burned gas. Operation of the heater in the event of catalyst poisoning may result in the dangers of fire, explosion and/or production of carbon monoxide. Injury, death and/or property damage can result. The heater should be taken out of service and returned to the factory or taken to a qualified LP Gas technician to have the catalyst pad replaced before it is used again.

CARE OF HEATER (cont.)

Observe these operating precautions:

- Locate heater away from furniture and drapes and out of traffic flow.
- Alert children and adults to the hazard of high surface temperatures. Caution them to stay away to avoid burns or clothing ignition.
- Carefully supervise young children when they are in the room with the heater.
- Do not place clothing or other flammable materials on heater.
- Do not remove safety guard from heater or operate heater with it not in place.

Partial parts list

Description	Part No.
Thermocouple	57794
Piezo Spark Ignitor	57800
Catalytic Heating Element (Wave 3)	57831
Catalytic Heating Element (Wave 6)	57836
Catalytic Heating Element (Wave 8)	57841
Control Knob	57781
Wave 3 Leg Stands for Portable Use	57701
Wave 3 Dust Cover – Wall Mount.....	57706
Wave 3 Dust Cover – Portable Use	57722
Wave 6 Leg Stands for Portable Use	57701
Wave 6 Recess Mounting Kit – Chrome...	57692
Wave 6 Dust Cover – Wall Mount	57713
Wave 6 Dust Cover – Portable Use.....	57723
Wave 8 Leg Stands for Portable Use	57701
Wave 8 Recess Mounting Kit – Chrome...	57695
Wave 8 Dust Cover – Wall Mount	57715
Wave 8 Dust Cover – Portable Use.....	57724

Note: A complete parts list, parts diagram and parts price list may be obtained by writing directly to Camco Mfg., Inc. Please include a stamped, self-addressed envelope when requesting a parts list. Please specify heater model and serial number.

The heater is designed as a non-vented, gas fired space heater. Such heaters have many uses in residential, agricultural, industrial, trade, service and recreational applications. Its use is intended for purposes described and limited by any applicable standards. Camco cannot anticipate all of the many applications for which catalytic heaters may be used. This heater should not be used for purposes not in conformance with its design, where non-vented heaters are not allowed. Such uses may be dangerous and could create hazardous conditions. Consult your local fire marshal or other governing authority if you have any other questions.

For service call or write:

Camco Mfg., Inc.

Olympian Division
 121 Landmark Drive
 Greensboro, NC 27409
 336-668-7661 ext. 231
 info@camco.net
 www.uscatalytic.com

For installation service or operating questions call

Technical Support ext. 169

To order parts or accessories call

Customer Service ext. 231

Notes: _____



Camco Mfg. Inc.
 121 Landmark Drive / Greensboro, NC 27409
 Phone: 800-334-2004 / fax: 336-668-2049
 www.uscatalytic.com · info@camco.net



Accessories for Your OLYMPIAN™ Heater

Leg Stands

To make Olympian Wave heaters portable. Leg stands fit all heaters models: Wave 3, Wave 6 and Wave 8
Part No. 57701

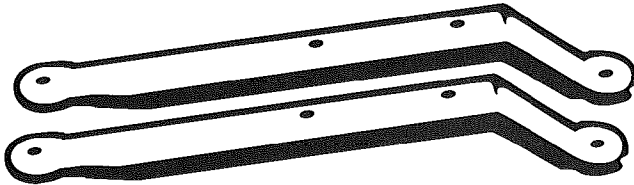

Recess Kits

Model	Part No.
Chrome Recess Kit	
Wave 6	57692
Wave 8	57695

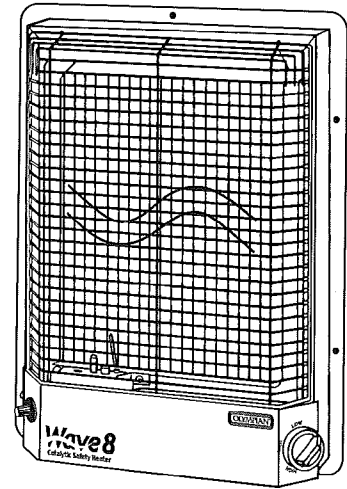

Custom Fitted Dust Covers

Model	Part No.
For wall-mount heaters	
Wave 3	57706
Wave 6	57713
Wave 8	57715
For portable heaters with leg stands	
Wave 3	57722
Wave 6	57723
Wave 8	57724

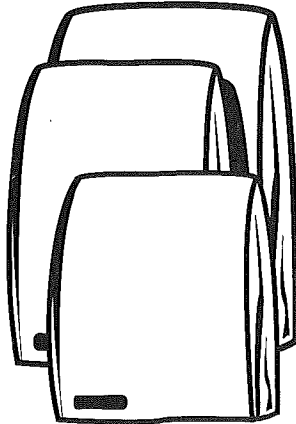

Low Pressure Regulator and Hose

For LP gas tank	
Length	Part No.
6 ft.	57703
8 ft.	57704
12 ft.	57721

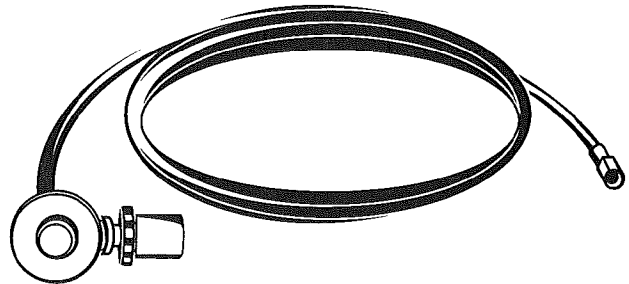

Elbow

90° Elbow
3/8" SAE male with 3/8" SAE female connector. Full 360° Swivel.
Part No. 57633

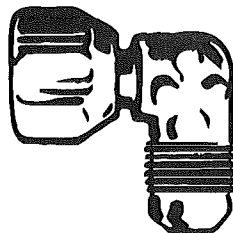

OLYMPIAN™ GUARANTEE





OLYMPIAN™ GUARANTEE: Camco Mfg., Inc. warrants the original purchaser that Olympian Wave heaters are free of defects in manufacture and workmanship for a period of 36 months from the date of consumer purchase. Camco Mfg., Inc. warranty covers the replacement of all parts free of charge. This warranty does not cover damages resulting from: misuse, alteration, improper installation or improper operations. This warranty does not cover repairs made by unauthorized persons or dealers, and specifically excludes liability for indirect or consequential damage to property. Warranty repairs must be made by Camco Mfg., Inc.



ordered Date (?)
9-22-08

Olympian™ Accessories Order Form

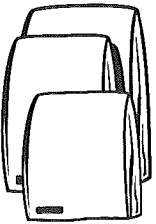
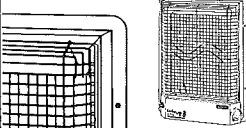
Item	Part #	Price ea.	Qty	Total
 90° Elbow 3/8" SAE male with 3/8" SAE female connector. Full 360° swivel.	57633	9.95	1	
LP Gas Hoses with regulator				
 Low Pressure Hose with Regulator for LP tank-6'	57703	25.75		
Low Pressure Hose with Regulator for LP tank-8'	57704	29.95		
Low Pressure Hose with Regulator for LP tank-12'	57721	33.25		
Leg Stands for Wave Heaters				
 Leg Stands to make Olympian Wave Heaters portable. One size fits Wave 3, Wave 6 or Wave 8 Heaters	57701	12.95	1	
Custom-fitted Dust Covers for every Wave Heater				
 Cover for wall-mounted Wave 3	57706	17.75		
Cover for wall-mounted Wave 6	57713	18.75		
Cover for wall-mounted Wave 8	57715	19.95		
Cover for portable Wave 3 with leg stands	57722	17.75		
Cover for portable Wave 6 with leg stands	57723	18.75		
Cover for portable Wave 8 with leg stands	57724	19.95		
Recess Kits for Wave 6 and 8 Heaters				
 Chrome Recess Kit for Wave 6	57692	22.95		
Chrome Recess Kit for Wave 8	57695	25.25		

Payment Method:

- Check
- MasterCard# _____
- VISA# _____

Card Expiration Date _____

Signature _____

Ship to:

Name: _____

Address: _____

City: _____

State / Zip: _____

Order Date: _____

E-mail: _____

subtotal		
6.75% Sales Tax NC Residents only		
Shipping & Handling*		
TOTAL		

* Shipping and Handling Charges:
For orders up to \$100, add \$9.84
For orders over \$100, add \$18.49

Online Ordering Available

Order by mail, phone or fax
or online at www.uscatalytic.com



Camco Mfg. Inc.
121 Landmark Drive / Greensboro, NC 27409
Phone: 800-334-2004 / fax: 336-668-2049
www.uscatalytic.com · info@camco.net

Prices effective June 1, 2007. Prices subject to change without notice.